



MANUAL WHEELCHAIR REFERENCE GUIDE

AUSTRALIA





YOU DRIVE OUR DESIGN

QUICKIE wheelchairs are designed for you and by you. In development, we consider how you interact with your wheelchair to maintain maximum efficiency, performance, fit, and style.

LEADING TECHNOLOGY

We are continually developing new products, improving our flagship products, and offering new options and solutions to enhance your lifestyle.

QUALITY AND DURABILITY

QUICKIE wheelchairs undergo rigorous testing that surpasses industry standards, so you can be confident that your product will hold up and perform throughout its lifetime.

ADJUSTABILITY AND VERSATILITY

Once you choose a QUICKIE, our goal is that it continues to be the right chair for you. We offer maximum adjustability in our designs, interchangeable parts, and the True Fit Growth Program* to help accommodate changes in your condition, environment or lifestyle.

*Available on select QUICKIE wheelchairs

BUILT-4-ME PERSONALISED

Our Built-4-Me Team is dedicated to creating product user-matched beyond what is listed on our product order forms. Experts in the engineering and manufacturing of configured rehab products will listen to your specific requests and build a chair as individual as your fingerprint!



RIGID FRAME

Krypton R	4
Nitrum	5
7 ^R Series	6
5 ^R	7
GP Series	8
QRi	9
RIGID Comparison Guide	10

FOLDING FRAME

Krypton F	13
Xenon ²	14
Quickie 2	15
QXi	16
M6	17
FOLDING Comparison Guide	18

TILT IN SPACE

Iris	20
Iris with Power Tilt	21
SR45	22
TILT IN SPACE Comparison Guide	23

JAY[®] Seating

JAY [®] Seating Selection	24
------------------------------------	----

KRYPTON R

CARBON FIBRE FRAME

REVOLUTIONARY
CARBON FRAME
WITH STAGGERING
STRENGTH-TO-
WEIGHT RATIO.

RIGID FRAME

*Ultra-lightweight from
3.65kgs in transit*



CARBON BRAID TECHNOLOGY



This QUICKIE Krypton Range features a patented and fully automated BRAID process that makes it possible to build the perfect frame – strong, light and manufactured with a precise and reliable automated process.

RIGIDITY & RAZOR-SHARP AGILITY



It's not only the exquisite material or the famously seductive styling, but also the athleticism and agility of a unique rigid wheelchair. Infinitely adjustable centre of gravity, fine-tuning of the front and rear seat heights and backrest angle adjustment ensures the Krypton R is designed for something truly special.

NITRUM

LIGHTEST IN CLASS

ENGINEERED
TO EFFICIENTLY
CONVERT YOUR
ENERGY INTO MOTION

Available in:

OPEN FRAME
DUAL FRAME

Nitrum boasts the largest range of sizes and adjustments in its class, so you can achieve your own perfect fit



LIGHT AND BACK SUPPORT

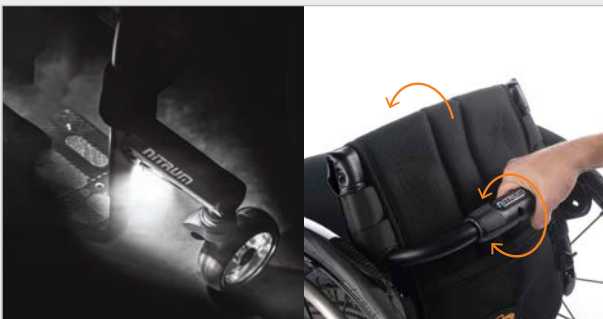

LED Lights mounted on each caster arm allow you to see and be seen.

One-handed folding back support offers you simple one-handed release and a clean look.

PATENTED, ADJUSTABLE CASTER SYSTEM



Instead of several welded parts, we use a reinforced and patented caster mechanism in a single hollow-forged component.

Fine-Tuned Adjustment

- Angle
- Camber
- Height

7^R SERIES

RIGID ACTIVE FRAME

STRENGTH IN
MOTION
DESIGNED TO MOVE
WITH YOU!

Available in:

7^R - ADJUSTABLE

7^{RS} - FIXED



FREESTYLE BACKREST



The 7 Series' minimal, ultra-modern design takes backstage so YOU are in the limelight.

Designed to break barriers to independence by providing a full range of upper body motion and lowering the overall weight of your chair.

TOP OF THE LINE TECHNOLOGY

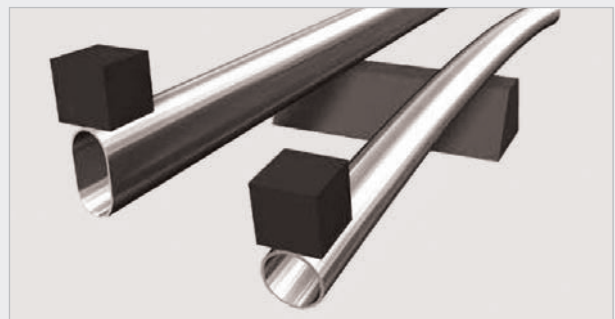

The genius behind the 7R Series' ultra lightweight frame is the 7000 Series aerospace aluminum that has been heat treated using ShapeLoc Technology.

The Result: thin, light tubing with strength & stiffness with a transport weight starting at 4.5kgs*

*Transport weight for the 7RS

QUICKIE 5^R

HIGHLY ADJUSTABLE FRAME

HIGHLY
ADJUSTABLE
TO ELEVATE YOUR
MOBILITY

Frame Styles:

CLASSIC

*Traditional frame length
for maximum stability*

PERFORMANCE

*Shortened length for
maximum responsiveness*



AXLE PLATE DESIGN



The 5R's swept-back axle plate design isn't just for looks.

It is also incredibly quick to adjust and is available in two lengths to ensure you are getting the adjustments you need without adding extra weight.

XTR SUSPENSION



The XTR Suspension Frame helps you fearlessly conquer curbs, bumps, and tough terrain. Add Mountain wheels, Knobby tires, wide casters, and Frog Legs suspension caster forks for the ultimate off-road wheelchair experience.

GP SERIES

RIGID WHEELCHAIR

A CLASSIC QUICKIE
RIGID WHEELCHAIR

Available in:

GP - Standard Style

GPV - Tapered for
increased maneuverability

GPSA - Swing Away
for easy transfers



THE ORIGINAL RIGID FRAME



The GP's classic box frame and one piece construction exceed our superior standard for quality and deliver an unmatched rigid feel.

SPORTS OPTION



The tapered GPV front frame, optional Quickie Performance wheels, and up to 12° of wheel camber combine for exceptional maneuverability on and off court.



QRI

RIGID MANUAL FRAME

NO-NONSENSE
UTILITY AND
UNBEATABLE VALUE



COMMUTER FRIENDLY DESIGN



- Ultra lightweight and durable aluminum frame, WC-19 Transit approved up to 120kgs
- Open frame and fluid caster housing design for a stylish look
- Small footprint for maneuverability and easy transport

COMFORTABLE FIT



The QRI comes standard with 0" or 1" of frame inset, a highly adjustable axle plate for perfecting your Center-of-Gravity setting, and multiple front frame angle options.



		
	Krypton R	Nitrum
SEAT WIDTH	32 - 46 cm	12 - 20"
SEAT DEPTH	34 - 48 cm	12 - 20"
FRONT SEAT HEIGHT	43- 55 cm	16 - 21"
REAR SEAT HEIGHT	38 - 50 cm	13 - 20"
FRAME STYLE	Carbon Fibre Open Frame	7020 Oval Aluminium
BACK HEIGHT	25 - 45 cm	8 - 20"
BACKREST ANGLE	-31° - 15°	-18° - 10°
FRAME / HANGER ANGLE	92° / 100°	75° / 80° / 85°
INSET	0" / 1"	0" / 1"/2"
CAMBER	0° / 3°	0° / 3° / 6°
MAX. USER WEIGHT	125 kg	125 kg
PRODUCT WEIGHT	3.65 kg transit / 6.2kg	4.9 kg transit / 8.3 kg
TRANSIT APPROVED	No	Yes*
FRAME COLOUR	5 Finishes	29 colours
WARRANTY	Limited Lifetime	Limited Lifetime
ARTG	100934	100167

RIGID FRAME SPECIFICATIONS

				
7 ^R	5 ^R	GP SA	GP/GPV	QRI
12 - 20"	12 - 20"	12 - 20"	12 - 22"	12 - 20"
12 - 20"	12 - 22"	12 - 22"	12 - 22"	12 - 20"
16 - 21"	16 - 21"	16.5 - 23"	15.5 - 23"	15 - 20"
13 - 20"	13 - 20"	16 - 20.5"	14 - 20.5"	14 - 20"
Open Series 7000 Aluminium	Open Series 5000 Aluminium	Traditional	Traditional	Open Series 5000 Aluminium
8 - 20"	10 - 20"	8 - 20"	8 - 20"	8 - 20"
-27° - 8°	-17° - 8°	-4° - 8°	-4° - 8°	-8° - 17°
75° / 80° / 85°	75° / 80° / 85°	60° / 70° / 90°	60° / 70° / 75° / 80°	75° / 80° / 85°
0" / 1" / 2"	0" / 1" / 2"	N/A	N/A on GP, 1" V taper on GPV	0, 1" V inset
0° / 3° / 6°	0°, 3°, 6°	(Adjustable) Set at 3°	(Adjustable) Set at 3°	0° / 3°
120 kg	120 kg	113 kg	113 kg	120 kg
5.1 kg transit / 8.5 kg	6.4 kg transit / 9.8 kg	8.6 kg transit / 12 kg	7.6 kg transit / 11 kg GP	6.6 kg transit / 10 kg
Yes*	Yes*	ISO Only - thru frame	N/A on GP, ISO Only - thru frame on GPV	Yes*
29 colours	28 colours	28 colours	28 colours	24 colours
Limited Lifetime	Limited Lifetime	Limited Lifetime	Limited Lifetime	Limited Lifetime
100167	100167	100167	100167	100167

*Conforms to ANDI/RESNA WC-19 Standards. Please refer to the Quickie & Zippie WC-19 Transit Securement Supplement





KRYPTON F

CARBON FIBRE FRAME

REVOLUTIONARY
CARBON FRAME
WITH STAGGERING
STRENGTH-TO-
WEIGHT RATIO

FOLDING FRAME

Ingeniously designed cross-brace with an open frame feel!



CARBON BRAID TECHNOLOGY



This QUICKIE Krypton Range features a patented and fully automated BRAID process that makes it possible to build the perfect frame – strong, light and manufactured with a precise and reliable automated process.

LIGHTEST FOLDING WHEELCHAIR



From just 5.8kgs in transit, the QUICKIE Krypton F is our lightest folding wheelchair yet! From every angle, the Krypton F is conceived to portray beauty. The heart of the Krypton F is its ingeniously designed cross-brace that fits so neatly under the seat it's barely noticeable giving a very minimalistic, open-frame feel.

QUICKIE 2

FOLDING WHEELCHAIR

ONE OF THE
LIGHTEST FOLDING
WHEELCHAIRS IN
THE WORLD!

Available in:

FF - Open fixed front frame

DUAL - Reinforced
fixed front frame

SA - Swing Away for easy
transfers



EASY TO FOLD MECHANISM

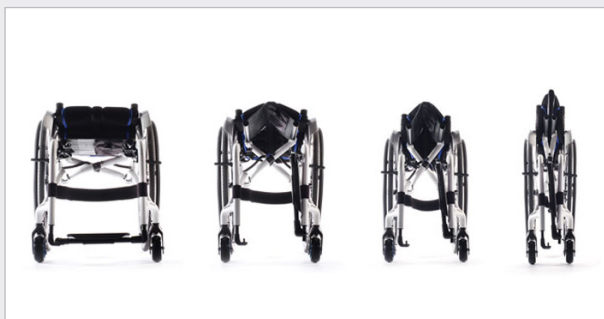

The aluminium latches on the cross-brace will also keep your wheels in parallel when folding and makes sure the chair stays folded when lifting.

ADJUSTABLE TO SUIT YOU



You want to change your chair driving characteristic from passive to more active or the opposite way? Just change the centre of gravity setting by simply repositioning the axle stem. And don't forget to adjust the back angle for your ergonomic posture.

XENON²

FOLDING FRAME

VERSATILE AND
MODULAR.
THE INDUSTRY'S
FAVORITE FOR OVER
25 YEARS!

Available in:

Q2 - Standard Modular
frame

Q2 LITE - Ultra lightweight,
modular frame

Q2 HP - High Performance



MODULAR FRAME DESIGN

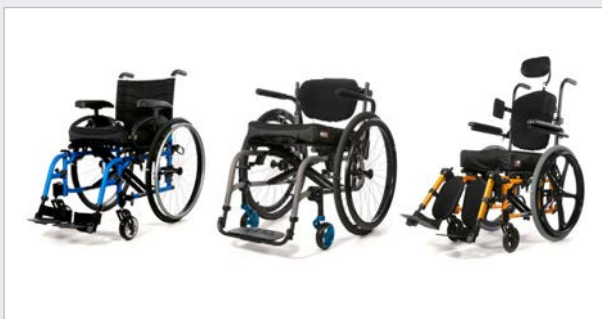

Featuring a modular design, the QUICKIE 2 offers the broadest range of possible configurations in the industry: over 100,000 different complex rehab options and counting. Designed to meet all of your unique needs without compromising fit or performance, only one wheelchair can live up to the name QUICKIE.

QUICKIE 2 LITE



Love the Quickie 2, but looking for something with an edge? The Quickie 2's minimalist counterpart, the Quickie 2 Lite, features an extremely lightweight, modular frame with a rounded rear for unique style and either fixed or swing-away front hangers.



QXI FOLDING WHEELCHAIR

LOW
MAINTENANCE
& SIMPLICITY



DURABLE FRAME DESIGN



- Ultra lightweight and durable folding frame with a 120kgs weight capacity
- One-piece side frames reduce moving parts
- Three arm cross brace sits inside frame for rigid ride

SIMPLE ADJUSTMENT & SERVICING



Most adjustments can be made in less than one minute, using only one tool - Center-of-Gravity (axle plate), Seat-to-floor height, Camber, Axle spacing and Back height.

M6

FOLDING BARIATRIC

IDEAL FOR
BARIATRIC CLIENTS
WEIGHING UP TO
295 KG & UPTO
75CM WIDE



MODULAR & HIGH-STRENGTH



The M6's modular frame, features high strength steel for increased durability. Its interchangeable, heavy duty components accommodate changing conditions with simple parts replacements.

LOCKING CROSS BRACE & STABILISER BAR

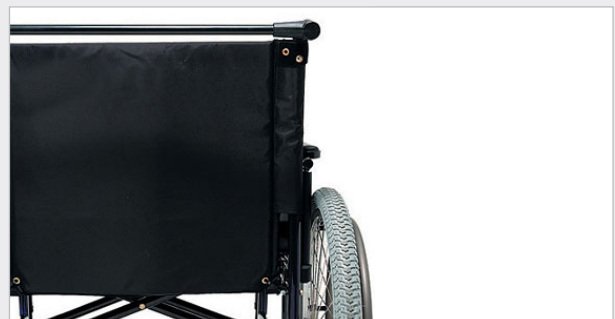

The M6 utilises a double locking cross brace and stabiliser bar to minimize frame flex and increase durability. The frame will hold an active user upto 295 kg.



Krypton F



Xenon² SA®



Xenon² FF®

	Krypton F	Xenon² SA®	Xenon² FF®
SEAT WIDTH	32 - 46 cm	32 - 50 cm	32 - 46 cm
SEAT DEPTH	34 - 48 cm	34 - 50 cm	34 - 50 cm
FRONT SEAT HEIGHT	43- 55 cm	43 - 56 cm	43 - 55 cm
REAR SEAT HEIGHT	37 - 50 cm	37 - 50 cm	37 - 50 cm
FRAME STYLE	Carbon Fibre Open Frame	Reinforced with swing-away front	Open frame with fixed front
BACK HEIGHT	25 - 47.5 cm	25 - 47.5 cm	25 - 47.5 cm
BACKREST ANGLE	75° to 103°	75° to 103° in 4° increments	75° to 103° in 4° increments
FRAME / HANGER ANGLE	92° / 100°	70° / 80°	92° / 100°
INSET	0 - 1 cm	N/A	0 - 1 cm
CAMBER	0° / 2° / 4°	0° / 2° / 4°	0° / 2° / 4°
MAX. USER WEIGHT	110 kg	125 kg	110 kg
PRODUCT WEIGHT	5.8 kg transit / 8.3 kg	7 kg transit / 10.3 kg	6.4 kg transit / 8.8 kg
TRANSIT APPROVED	No	Yes	Yes
FRAME COLOUR	5 Finishes	32 colours	32 colours
WARRANTY	Limited Lifetime	Limited Lifetime	Limited Lifetime
ARTG	100934	100934	100934

FOLDING FRAME SPECIFICATIONS

				
Xenon ² Dual®	Quickie 2 Lite	Quickie 2	OXi	M6
32 - 50 cm	14 - 20"	12 - 24"	14 - 20"	22 - 30"
34 - 50 cm	14 - 20"	12 - 22"	14 - 20"	18 - 22"
43 - 55 cm	14.5 - 21.5"	13.5 to 22"	12.5 - 19.5"	17 - 20"
37 - 50 cm	13 - 19.5"	13 to 22"	12 - 19"	17 - 20"
Reinforced with fixed front	Traditional - Fixed or SA front	Traditional- Fixed or SA front	Traditional	Heavy Duty
25 - 47.5 cm	9 - 21"	9 - 21"	13 - 20"	17 - 20"
75° to 103° in 4° increments	-14° - +5° (optional)	-15° - +3° (Optional)	-15° - 3°	N/A
92° / 100°	70° / 80°	60° / 70° / 80° / 90°	60° / 70° / 80°	N/A
0 - 1 cm	0 / 1" each side	N/A	N/A	N/A
0° / 2° / 4°	(Adjustable) Set at 3°	(Adjustable) Set at 3°	(Adjustable) Set at 3°	0°
140 kg	120 kg	136 kg Std / 158 kg HD	136 kg	295 kg
7.2 kg transit / 9.5 kg	7.3 kg transit / 10.6 kg	8.2 kg transit / 11.5 kg	9.9 kg transit / 13.25 kg	24 kg
Yes	Yes	Yes	Yes	No
32 colours	24 colours	24 colours	24 colours	24 colours
Limited Lifetime	Limited Lifetime	Limited Lifetime	Limited Lifetime	Limited Lifetime
100934	100167	100167	100167	100167



IRIS TILT IN SPACE

INTELLIGENT ROTATION IN SPACE TECHNOLOGY

*One of the best and lightest
tilt-in-space wheelchairs on
the market*



INTELLIGENT ROTATION



The Quickie IRIS features up to 55° of Intelligent Rotation in Space Technology to achieve superior positioning and is designed to facilitate feeding and respiratory function, reduce pressures and improve visual alignment.

MONO BACKREST SYSTEM



The MONO Backrest System's single back post offers limitless seating and positioning capabilities. By mounting the backrest to a single central post, the backrest and chair widths may be selected independently to accommodate users with varying torso and hip widths.

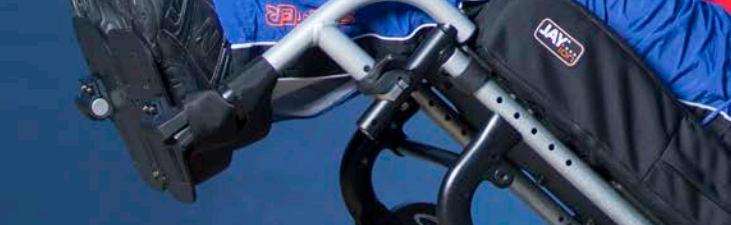

IRIS WITH POWER TILT

HAVE MORE
CONTROL OVER THE
POSITION OF YOUR
BODY IN SPACE



Available in:
IRIS
IRIS Heavy Duty
- improves comfort by assisting with sitting tolerance
- provides more independence to participate in daily activities

ATTENDANT CONTROL



Allows the carer to give control of the tilt function to the user. The battery gauge is displayed on the top of the control so you never have to guess when it's time to charge. Ability to conveniently hang the attendant control anywhere on the chair.

TOGGLE SWITCH



Can be mounted vertically or horizontally depending on needs. Charging port is conveniently located on the toggle switch for easy access.

SR45

TILT IN SPACE

PRE-CONFIGURED
FOR EASE OF
ORDERING



45° OF ROTATION-IN-SPACE



The Quickie SR45's seat frame rotates around the client's centre of gravity providing the shortest possible wheelbase without compromising stability. When the centre of gravity and centre of rotation are properly aligned, tilting is smooth, easy and controlled.

STANDARD SMART PACKAGE



SR45 comes standard with - Non folding back canes, Height adjustable back with adjustable stroller handles, Foot tilt, Transit tie downs, Dual post height adjustable flip back with full length arm pads, 70° Swing in/ out hangers, solid seat pan and rear anti tips and composite foot plates.

TILT IN SPACE SPECIFICATIONS



IRIS

SR45

SEAT WIDTH	14 - 22"	16 x 16"
SEAT DEPTH	14 - 22"	18 x 18"
FRONT SEAT HEIGHT	12.5 - 19"	20 x 18"
REAR SEAT HEIGHT	12.5 - 19"	17"
FRAME STYLE	Rotation In Space	Rotation In Space
BACK HEIGHT	15 - 24"	21"
BACKREST ANGLE	-5° to +30°	-5° to +30°
FRAME / HANGER ANGLE	60° / 70° / 80° / 90° / Elevating	70°
INSET	N/A	N/A
CAMBER	0°	0°
MAX. USER WEIGHT	136 kg / HD 181 kg	120 kg
PRODUCT WEIGHT	17.6 kg	17.6 kg
TRANSIT APPROVED	Yes	Yes
FRAME COLOUR	25 colours	Black
WARRANTY	Limited Lifetime	Limited Lifetime
ARTG	100167	100167





SEATING SELECTION

JAY® CUSHIONS



Basic



Basic^{PRO}



GO™



Soft Combi™ P



X2™



Easy™



Ion™



Union™



Fusion™



Cryo Fusion™



J2™



J2™ Deep Contour

JAY® BACKS



Basic



GO™



J3™ Plus



Focus Point



J3™ Posterior



J3™ Posterior & Lateral



J3™ PD, PDL & PDC

To learn about personalising JAY seating products, visit the JAY Your Way product page on www.SunriseMedical.com.au



Sunrise Medical Australia Pty Ltd
 11 Daniel Street, Wetherill Park, NSW 2164
 Phone: (02) 9678 6600
 Email: enquiries@sunrisemedical.com.au
 Website: www.sunrisemedical.com.au